



Design

Vincent Van Duysen

2025

Divani monoblocco, componibili e pouf
Struttura in multistrato. Imbottitura bracciolo, schienale e sedile a quote differenziate di poliuretano CIRCULARREFOAM® composto da una percentuale di polioli riciclati/fibra in PET con una percentuale di riciclato post-consumo. Assemblaggio parti privo di collanti. Cuscino schienale in fibra soffiata e tela di PET riciclato. Rivestimento esterno amovibile in stoffa.

Monobloc, modular sofas and pouf
Plywood frame. Armrest, backrest and seat padding in graduated CIRCULARREFOAM® polyurethane comprising a percentage of recycled polyols/PET fibre including a percentage of post-consumer recycled material. Parts assembly without glues. Backrest cushion in blown PET fibre and PET canvas. Removable external cover in fabric.

Canapés monoblocs, composables et pouf
Structure multicouche. Rembourrage des accoudoirs, du dossier et de l'assise en polyuréthane CIRCULARREFOAM® à densités variables, composé d'un pourcentage de polyols recyclés/fibre de PET avec un pourcentage de matériau recyclé post-consommation. Assemblage des pièces sans adhésifs. Coussin de dossier en fibre soufflée et toile de PET recyclé. Revêtement extérieur déhoussable en tissu.

Einteilige, zusammenstellbare Sofas und Hocker
Sperrholzgestell. Polsterung von Armlehnen, Rückenlehnen und Sitzflächen in abgestufter CIRCULARREFOAM®-Polyurethan, bestehend aus einem Prozentsatz recycelter Polyole/PET-Fasern einschließlich eines Prozentsatzes post-consumer Recyclingmaterials. Montage der Teile ohne Klebstoffe. Rückenkissen aus geblasener PET-Faser und PET-Gewebe. Abnehmbarer Außenbezug aus Stoff.

Sofás monobloque, modulares y pouf
Estructura de madera contrachapada. Acolchado de brazos, respaldo y asiento en poliuretano CIRCULARREFOAM® con densidades diferenciadas, compuesto por un porcentaje de poliols reciclados/fibra de PET con un porcentaje de material reciclado postconsumo. Montaje de piezas sin colas. Cojín de respaldo en fibra soplada y lona de PET reciclado. Tapizado exterior desenfundable en tejido.

1338/100

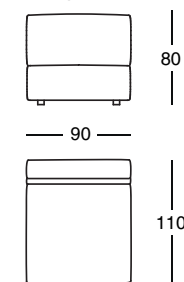

1338/101

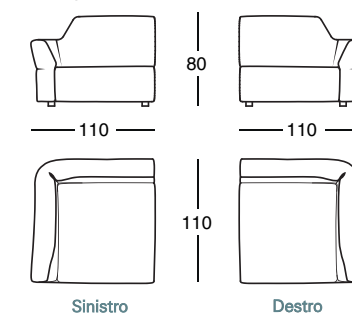

1338/125

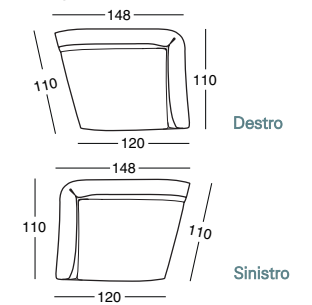

1338/201

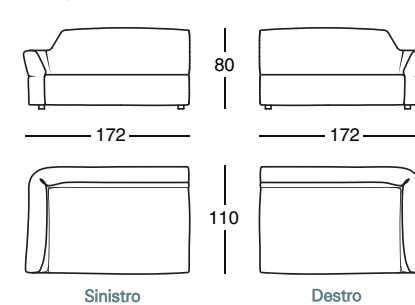

1338/201C

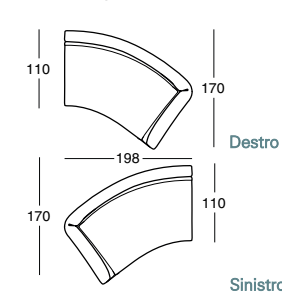

1338/202

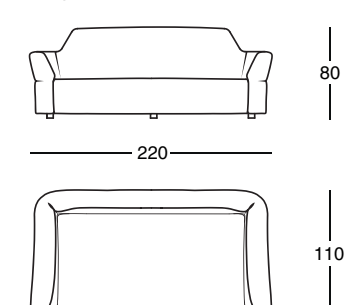



1338/212

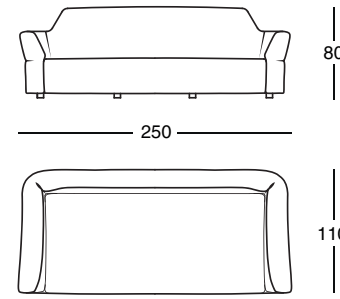

1338/302

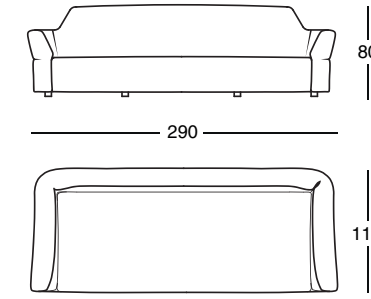

1338/AL1

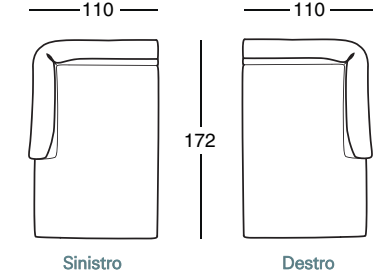

1338/ANG1

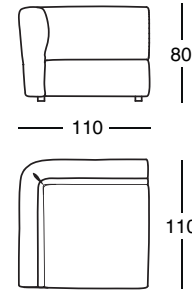

1338/POUF

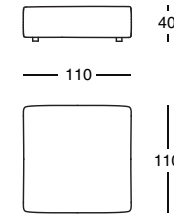

1338/55C

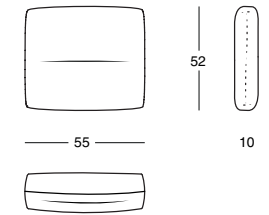

1338/65C

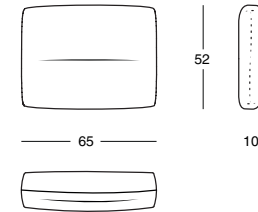

1338/75C

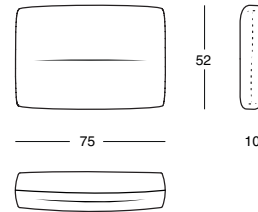

1.

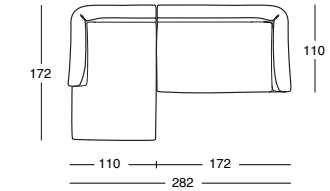

2.

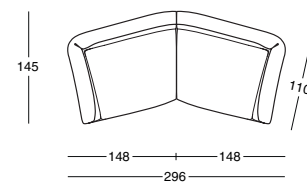

3.

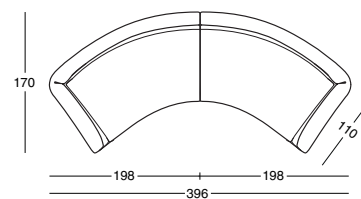

4.

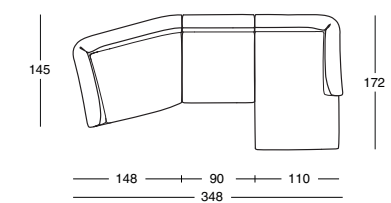

5.

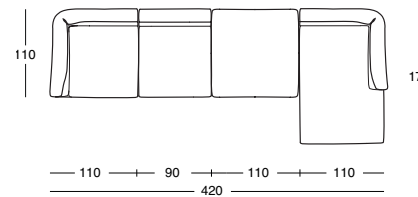

6.

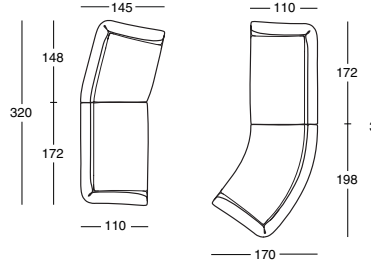

7.

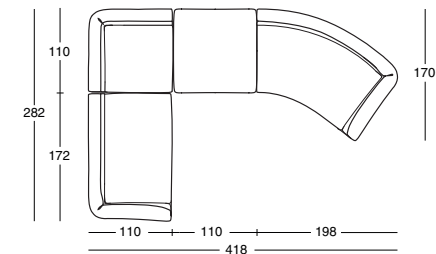

8.

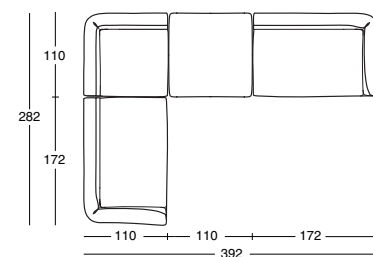

9.

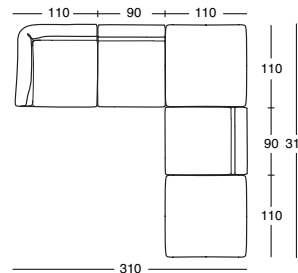

10.

