

BONALDO

Alicanto

Designer: Gabriele & Oscar Buratti



The Alicanto oak sideboards are available in two versions: a horizontal version with four doors and a vertical version with two doors and an open upper unit, designed to be used individually or combined in coordinated compositions.

The different heights define distinct proportions and characters: in the horizontal version (available in two heights, Alicanto and Alicanto midi), the volume develops in a more compact way, while in the Alicanto high version the open upper unit emphasises verticality and lightens the overall perception. An elegant and discreet detail, the result of a precise design choice, is represented by the side panels with a lenticular section, which extend down to the floor to form the base of the piece.

The structure of Alicanto is made of brown oak or charcoal oak. The top can be in wood, for a monomaterial finish, or in ceramic, introducing a refined contrast between materials.

Data sheet

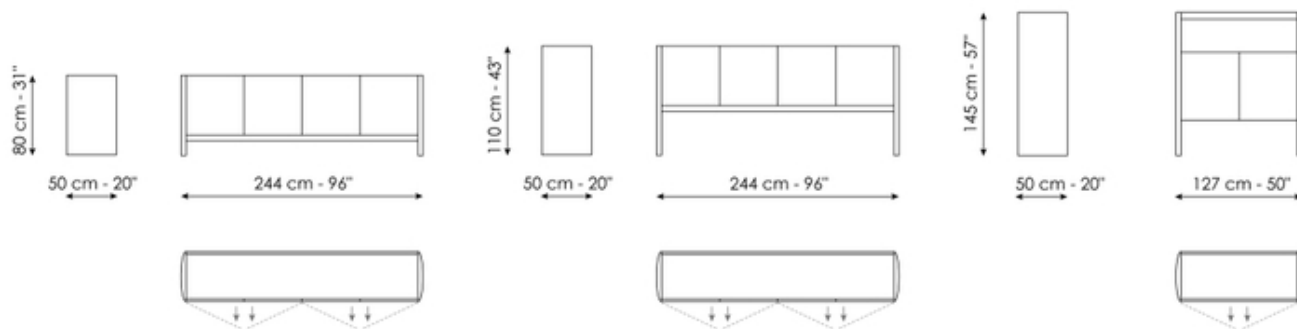

Alicanto

Width: 244cm

Depth: 50cm

Height: 80cm

Alicanto midi

Width: 244cm

Depth: 50cm

Height: 110cm

Alicanto high

Width: 127cm

Depth: 50cm

Height: 145cm

Finishes

Frame



Veneered wood
Coal oak

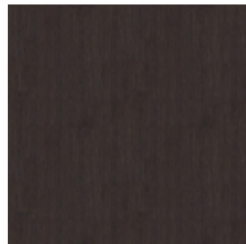

Veneered wood
Brown oak

Top

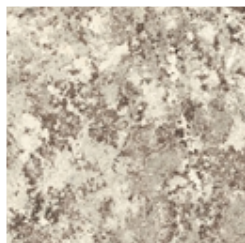

Mat ceramic
Alaska White

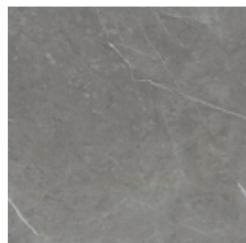

Mat ceramic
Ardesia grey



Mat ceramic
Augusta

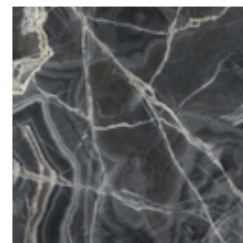

Glossy ceramic
Black Onyx

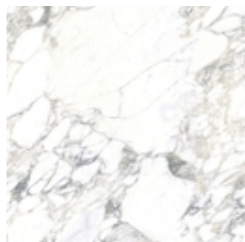

Glossy ceramic
Calacatta

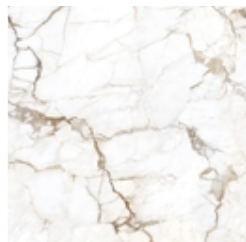

Silk finish ceramic
Calacatta macchia vecchia

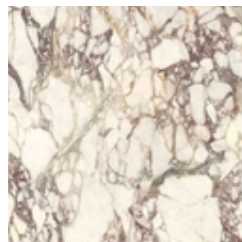

Glossy ceramic
Calacatta Viola



Silk finish ceramic
Daino Grigio

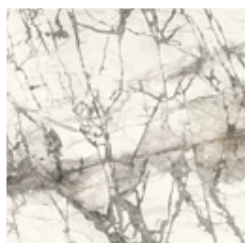

Glossy ceramic
Imperial grey

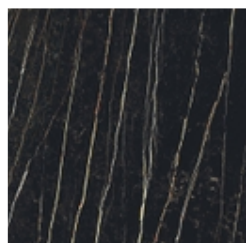

Mat ceramic
Laurent



Glossy ceramic
Mountain peak

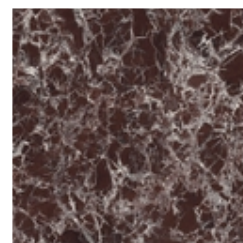

Glossy ceramic
Rosso imperiale